

IN-SIGHT D900 VISION SYSTEM

Powered by In-Sight ViDi
Deep Learning-Based Vision Software

The In-Sight® D900 is a vision system powered by In-Sight ViDi™ software designed specifically to run deep learning applications. This embedded solution helps factory automation customers easily solve challenging OCR, assembly verification, and defect detection applications that are often too difficult to deploy with traditional, rule-based machine vision tools and require reliable, fast and consistent results not possible with human inspection.

In-Sight ViDi applications are deployed on the In-Sight D900 smart camera without the need for a PC, making deep learning technology accessible to non-programmers. It uses the familiar and easy-to-use In-Sight software platform which simplifies application development and factory integration.



In-Sight ViDi Read tool solves challenging OCR applications in minutes

The In-Sight D900 deciphers badly deformed, skewed, and poorly etched codes using optical character recognition (OCR). The In-Sight ViDi Read tool works right out of the box, dramatically reducing development time, thanks to the deep learning pretrained font library. Simply define the region of interest and set the character size. In situations where new characters are introduced, this robust tool can be retrained to read application-specific characters that traditional OCR tools are not able to decode.

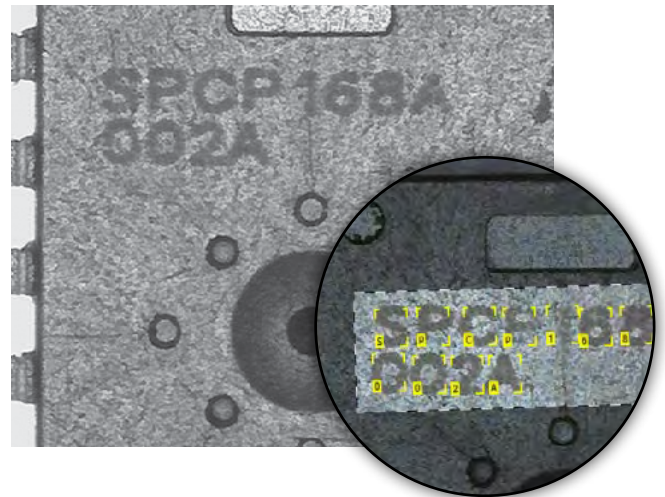

In-Sight ViDi Check tool performs fast and accurate assembly verification

The In-Sight D900 reliably detects complex features and objects and verifies parts and kits are assembled correctly based on their location within a user-defined layout. The In-Sight ViDi Check tool can be trained to create an extensive library of components, which can be located in the image even if they appear at different angles or vary in size.

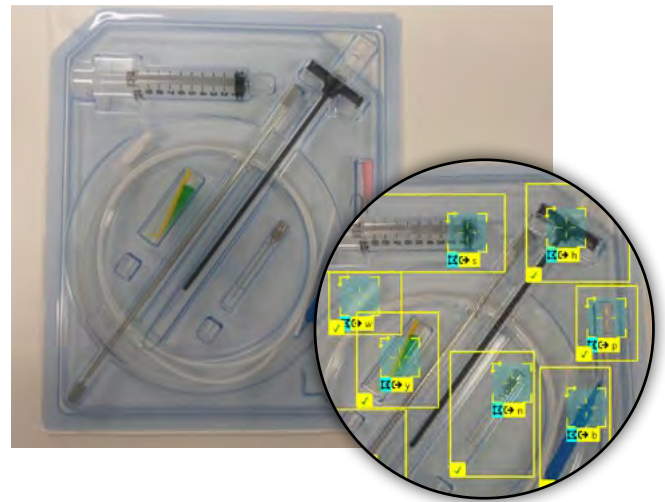
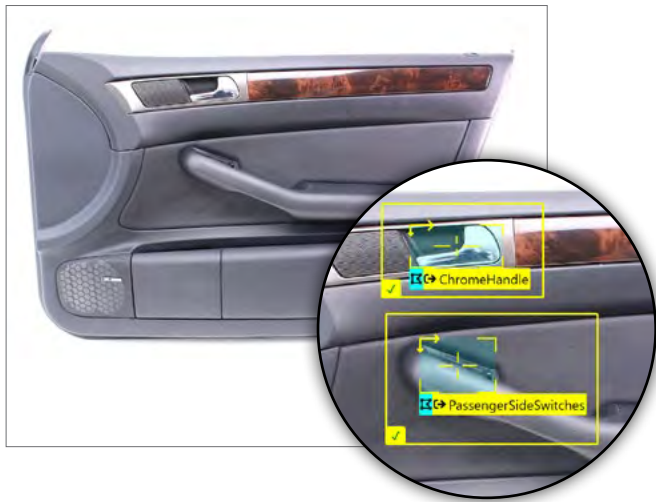

In-Sight ViDi Detect tool analyzes complex defect detection tasks

The In-Sight ViDi Detect tool learns from images of good parts in order to identify defective parts. In-Sight ViDi Detect is ideal for finding anomalies on complex parts and surfaces, even in situations where defects can be unpredictable in their appearance.

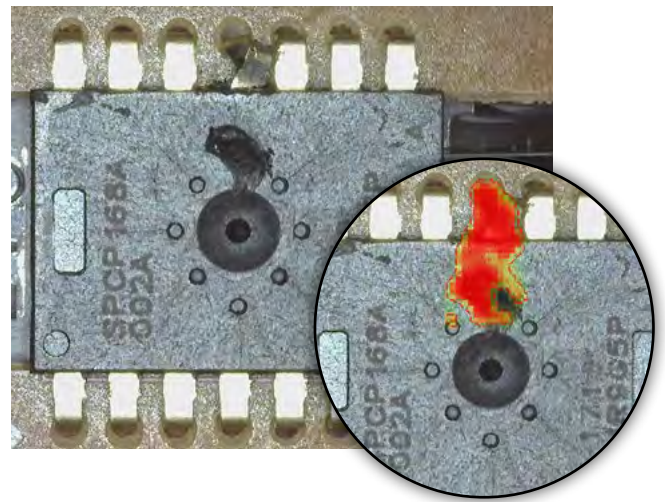
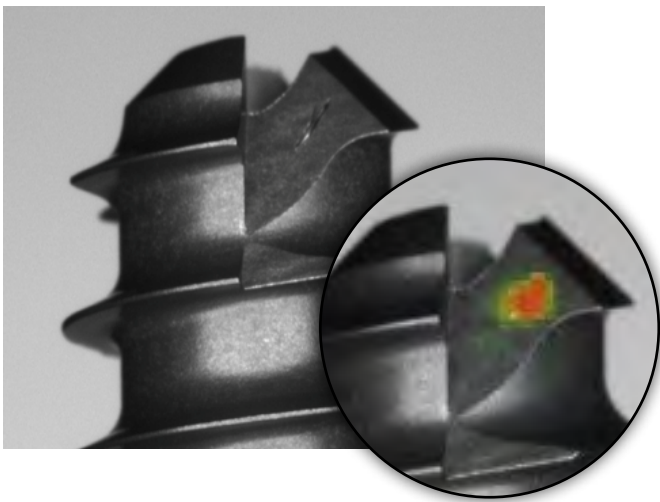

In-Sight spreadsheet guides application development

In-Sight ViDi takes advantage of the intuitive In-Sight spreadsheet interface to quickly set up and run deep learning applications without programming. The In-Sight spreadsheet simplifies application development and streamlines factory integration with a full I/O and communications function set. It also enables the ability to combine traditional Cognex rules-based vision tools (like PatMax Redline™) and deep learning tools in the same job, leading to quicker deployments. Since In-Sight ViDi requires vastly smaller image sets and shorter training and validation periods than other deep learning solutions, applications are quick and easy to set up, teach, and deploy.

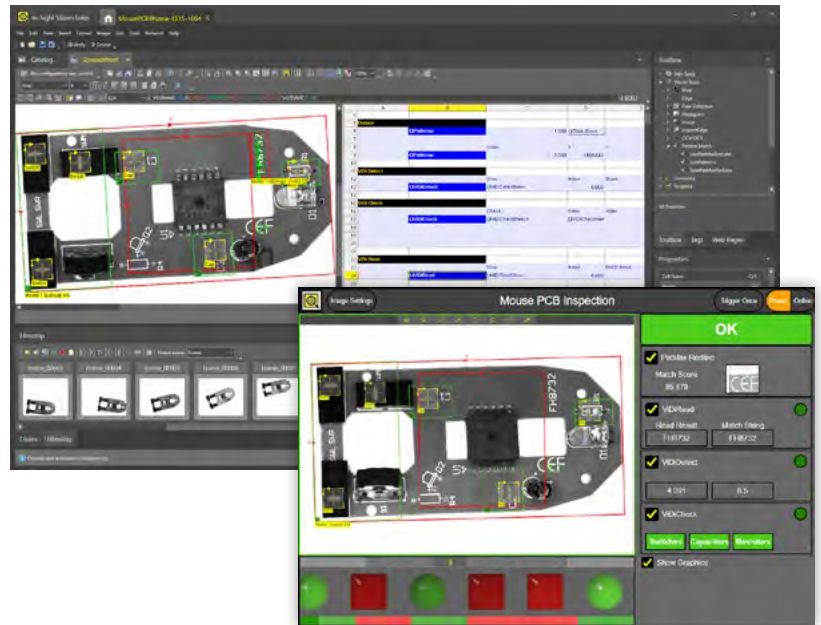

Deployed on powerful, customizable vision systems

In-Sight ViDi applications on the In-Sight D900 can be deployed without a PC. This highly-modular, IP67-rated vision system includes field-changeable lighting, lenses, filters, and covers that can be customized to match your exact application requirements. It also includes an embedded inference engine that is specifically designed to solve complex deep learning applications at production line speeds.



Available in 2.3MP and 5MP models

High sensitivity CMOS is compatible with C-mount lenses

IP67-rated C-mount lens covers are available for protection in harsh environments and support wider diameter lenses



Local file storage on SD card

LED indicator allows pass/fail monitoring at a distance

High Dynamic Range (HDR+) imaging creates evenly exposed images

Advanced vision tools solve a wide range of applications

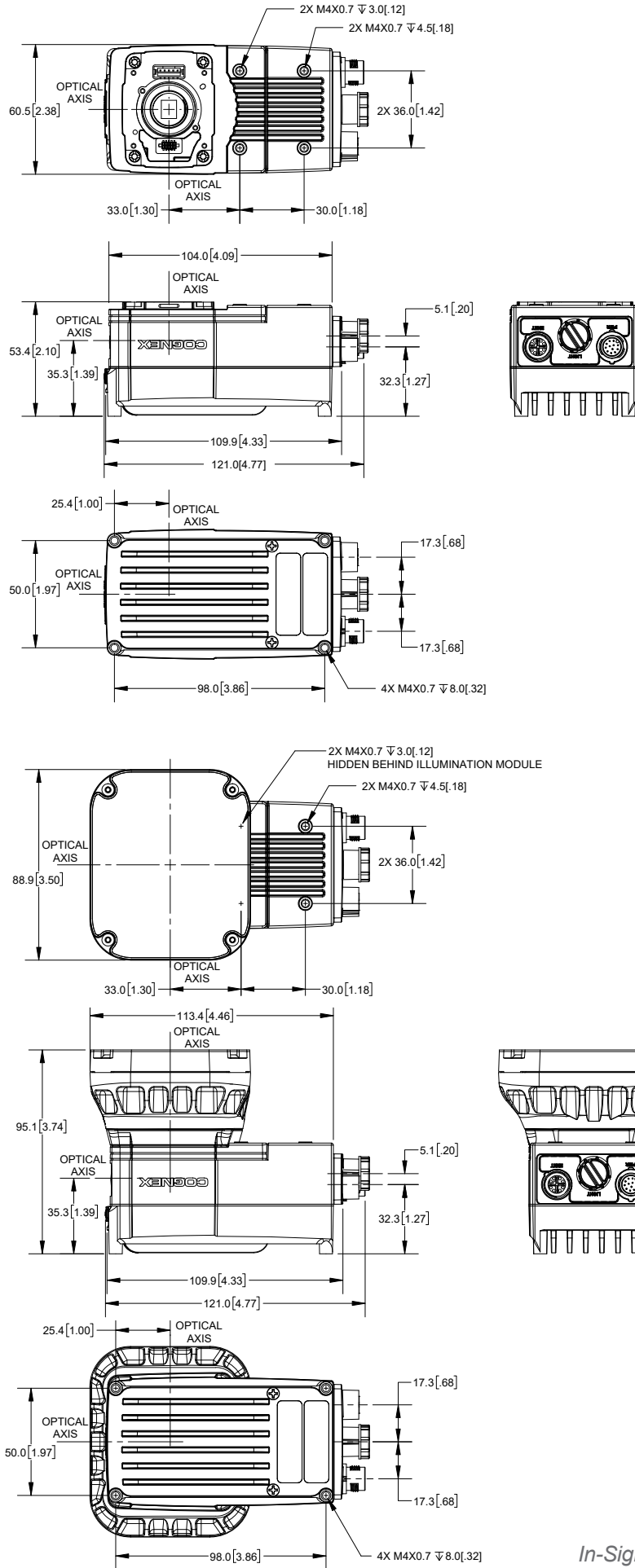

In-Sight ViDi workflow

In-Sight ViDi applications are trained on a GPU-enabled, Windows-based PC using an In-Sight ViDi training license. Once configured, projects are deployed on the In-Sight D900 vision system powered by the embedded ViDi software.

IN-SIGHT D900 SPECIFICATIONS

		D905M	D905C	D902M	D902C
Image Type		Monochrome	Color	Monochrome	Color
Imager Type		2/3 inch CMOS (3.45 µm x 3.45 µm pixels)		1/2.3 inch CMOS (3.45 µm x 3.45 µm pixels)	
Resolution (pixels)		5 MP (2448 x 2048)		2.3 MP (1920 x 1200)	
Acquisition Speed (Max)		26 fps	16 fps	51 fps	34 fps
Memory	File storage	16GB non-volatile flash memory; unlimited storage via remote network device			
	Processing	3GB SDRAM			
	Additional Storage	8 GB SD card, network drive via FTP over gigabit network			
Optics	Lenses	C-Mount, S-Mount, Autofocus			
	Indicator LEDs	SD card status, pass/fail LED and 360° viewing indicator ring, network LED, and error LED			
	Lighting	External lights via light control connector			
I/O	Network	Gigabit Ethernet (10/100/1000 Mbps)			
	Built-in	1 dedicated trigger IN, 1 general purpose IN, 2 general purpose OUT, 2 bi-direction IN/OUT			
Mechanical	Industrial M12 Connectors	Power/I/O; Ethernet; External light power/control			
	Dimensions	53.4 mm (2.10 in) x 60.5 mm (2.38 in) x 121.0 mm (4.77 in)			
	Weight	380 g (13.4 oz.)			
	Protection	IP67 with C-mount lens cover or integrated light connected			
Power		24 VDC			



Companies around the world rely on Cognex vision and barcode reading solutions to optimize quality, drive down costs and control traceability.

Corporate Headquarters One Vision Drive Natick, MA 01760 USA

Regional Sales Offices

Americas

North America +1 844-999-2469
 Brazil +55 (11) 2626 7301
 Mexico +800 733 4116

Europe

Austria +49 721 958 8052
 Belgium +32 289 370 75
 France +33 1 7654 9318

Germany +49 721 958 8052
 Hungary +36 800 80291
 Ireland +44 121 29 65 163
 Italy +39 02 3057 8196
 Netherlands +31 207 941 398
 Poland +48 717 121 086
 Spain +34 93 299 28 14
 Sweden +46 21 14 55 88
 Switzerland +41 445 788 877
 Turkey +90 216 900 1696
 United Kingdom +44 121 29 65 163

Asia

China +86 21 6208 1133
 India +9120 4014 7840
 Japan +81 3 5977 5400
 Korea +82 2 530 9047
 Malaysia +6019 916 5532
 Singapore +65 632 55 700
 Taiwan +886 3 578 0060
 Thailand +66 88 7978924
 Vietnam +84 2444 583358

© Copyright 2020, Cognex Corporation. All information in this document is subject to change without notice. All Rights Reserved. Cognex and In-Sight are registered trademarks of Cognex Corporation. ViDi and PatMax RedLine are trademarks of Cognex Corporation. All other trademarks are property of their respective owners. Lit. No. ISD900-DS-09-2020

www.cognex.com